



BETA181

Ultra-Compact Side-Address Microphone

Online user guide for Shure BETA181 side-address condenser microphone.
Version: 3.1 (2023-I)

Table of Contents

BETA181 Ultra-Compact Side-Address Microphone	3	Changing Capsules	5
General Description	3	Load Impedance	6
Features	3	Power Requirements	6
Variations	3	Specifications	6
Performance Characteristics	3	Accessories	9
Applications	3	Furnished Accessories	9
Positioning the Microphone	3	Optional Accessories	10
General Rules for Use	4	Certifications	10
Applications and Placement	4		
Avoiding Pickup of Unwanted Sound Sources	4		

BETA181

Ultra-Compact Side-Address Microphone

General Description

The Shure Beta 181 is an ultra-compact, side-address, condenser microphone, designed for discreet placement in live and studio environments. Featuring interchangeable cardioid, supercardioid, omnidirectional and bidirectional capsules for superior versatility, the small diaphragm of the Beta 181 provides superior audio with consistent, “textbook” polar responses in a form factor small enough to get close to the source in the tightest conditions.

Features

- Premier live performance microphone with Shure quality, ruggedness, and reliability
- Compact preamp attaches to four interchangeable capsules
- Wide dynamic range for use in high SPL environments
- Side-address form allows for discreet positioning in tight performance and recording settings
- Innovative locking ring provides a secure connection between capsule and preamp
- Hardened steel mesh grille resists denting, wear, and abuse
- Compact design, under 12 cm (5 in.), reduces stage clutter
- Furnished with stand adapter and carrying case

Variations

- **Beta 181/C** Cardioid Microphone
- **Beta 181/S** Supercardioid Microphone
- **Beta 181/O** Omnidirectional Microphone
- **Beta 181/BI** Bidirectional Microphone

Performance Characteristics

- Exceptional low-frequency reproduction
- Extremely high SPL handling
- High output level
- No crossover distortion
- Transformer output

Applications

Positioning the Microphone

The front of the microphone is marked by the Shure logo. Position this side toward the sound source.

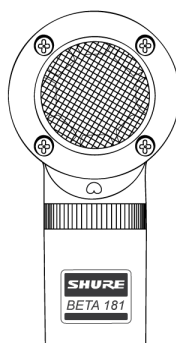

General Rules for Use

- Do not cover any part of the microphone grille with your hand, as this will adversely affect microphone performance.
- Aim the microphone toward the desired sound source (such as the talker, singer, or instrument) and away from unwanted sources.
- Place the microphone as close as practical to the desired sound source.
- Work close to the microphone for extra bass response.
- Use only one microphone to pick up a single sound source.
- For better gain before feedback, use fewer microphones.
- Keep the distance between microphones at least three times the distance from each microphone to its source (“three to one rule”).
- Place microphones as far as possible from reflective surfaces.
- Add a windscreen when using the microphone outdoors.
- Avoid excessive handling to minimize pickup of mechanical noise and vibration.

Applications and Placement

The following table lists the most common applications and placement techniques. Keep in mind that microphone technique is largely a matter of personal taste; there is no one “correct” microphone position.

Cardioid	Supercardioid	Omnidirectional	Bidirectional
Drum overheads Piano Acoustic instruments Pair with a Beta 181/BI for M/S stereo technique	Close-miking in performance settings Snare drum Acoustic instruments	Room and ambient pickup Mono drum overhead String ensembles	Use a pair of Beta 181/BI for Blumlein stereo technique Mono drum overhead Dual sound sources, such as between tom-toms or acoustic instruments

As with all bidirectional microphones, sounds picked up from the back will be out of polarity with the source. Those from the front are in polarity with the source.

Avoiding Pickup of Unwanted Sound Sources

Directional microphones are most sensitive to sounds arriving on axis and reject at angles depending upon the polar pattern. The following chart shows the rejection angles of each microphone. In live performance or recording settings, align monitors, P.A. loudspeakers, and unwanted sound sources at these angles.

To minimize feedback and ensure optimum rejection of unwanted sound, always test microphone placement before a performance.

Cardioid	Supercardioid	Bidirectional
Off-axis null points at 180 degrees	Off-axis null points at 120 degrees	Off-axis null points at 90 degrees

Changing Capsules

Follow these steps to change Beta 181 capsules:

1. Turn off phantom power and disconnect from equipment.
2. Unscrew the capsule's knurled ring to detach the preamp.
3. Slide the alignment key on the bottom of the capsule into the groove on the preamp to ensure that the Shure logo displays the front of the microphone.
4. Tighten the knurled ring to securely reconnect the microphone.

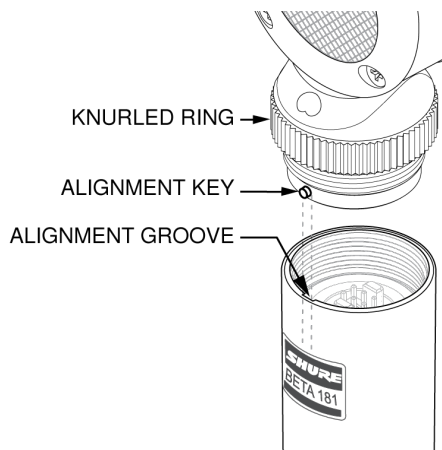
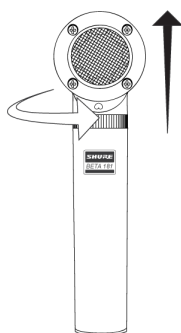

NOTE: Before each use, make sure the capsule is tightly secured on the microphone, as vibration and accidental hits with drumsticks may loosen it, resulting in signal loss.

Load Impedance

Maximum SPL capability, output clipping level, and dynamic range vary with the input load impedance of the preamplifier to which you connect the microphone. Shure recommends a minimum input load impedance of 1000 Ω . Most modern microphone preamplifiers meet this requirement. Higher impedance results in better performance for these specifications.

Power Requirements

This microphone requires phantom power and performs best with a 48 Vdc supply (IEC-61938). However, it will operate with slightly decreased headroom and sensitivity with supplies as low as 11 Vdc.

Most modern mixers provide phantom power. You must use a **balanced** microphone cable: XLR-to-XLR.

Specifications

Type

Electret Condenser

Polar Pattern

181/C:	Cardioid
181/S:	Supercardioid
181/O:	Omnidirectional
181/BI:	Bidirectional

Frequency Response

20 to 20,000 Hz

Output Impedance

110 Ω

Sensitivity

open circuit voltage, @ 1 kHz, typical

Cardioid	-46.5 dBV/Pa[1] (4.7 mV)
Supercardioid	-49.5 dBV/Pa[1] (3.4 mV)
Omnidirectional	-52.0 dBV/Pa[1] (2.5 mV)
Bidirectional	-51.0 dBV/Pa[1] (2.8 mV)

Maximum SPL

1 kHz at 1% THD[2]

2500 Ω load	Cardioid	151.5 dB SPL
--------------------------------------	----------	--------------

	Supercardioid	154.5 dB SPL
	Omnidirectional	157.0 dB SPL
	Bidirectional	156.0 dB SPL
	Cardioid	149.0 dB SPL
1000 Ω load	Supercardioid	152.0 dB SPL
	Omnidirectional	154.0 dB SPL
	Bidirectional	153.5 dB SPL
	Cardioid	149.0 dB SPL

Signal-to-Noise Ratio[3]

Cardioid	73.5 dB
Supercardioid	71.5 dB
Omnidirectional	70.5 dB
Bidirectional	71.0 dB

Dynamic Range

2500 Ω load	Cardioid	131.0 dB
	Supercardioid	132.0 dB
	Omnidirectional	133.5 dB
	Bidirectional	133.0 dB
1000 Ω load	Cardioid	128.5 dB
	Supercardioid	129.5 dB
	Omnidirectional	130.5 dB
	Bidirectional	130.5 dB

Clipping Level

@ 1 kHz, 1% THD

2500 Ω load	10.5 dBV
1000 Ω load	7.5 dBV

Self Noise

equivalent SPL, A-weighted, typical

Cardioid	20.5 dB SPL-A
Supercardioid	22.5 dB SPL-A
Omnidirectional	23.5 dB SPL-A
Bidirectional	23.0 dB SPL-A

Common Mode Rejection

20 to 20,000 kHz

≥55 dB

Polarity

Positive pressure on diaphragm produces positive voltage on pin 2 with respect to pin 3

Power Requirements

11–52 V DC[4] phantom power (IEC-61938)

2.4 mA, maximum

Weight

145 g (5.1 oz.)

[1] 1 Pa=94 dB SPL

[2]THD of microphone preamplifier when applied input signal level is equivalent to cartridge output at specified SPL

[3]S/N ratio is the difference between 94 dB SPL and equivalent SPL of self noise, A-weighted

[4]All specifications measured with a 48 Vdc phantom power supply. The microphone operates at lower voltages, but with slightly decreased headroom and sensitivity.

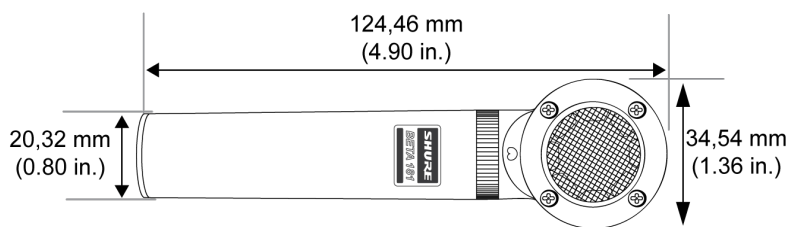

Overall Dimensions

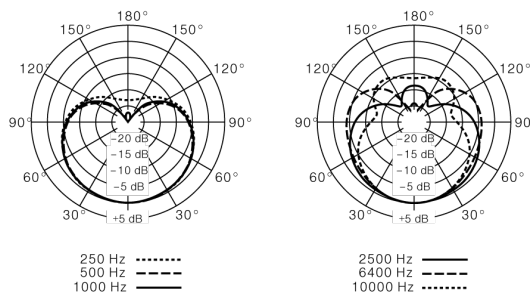
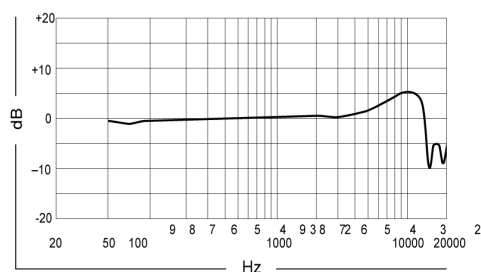

Beta 181/C

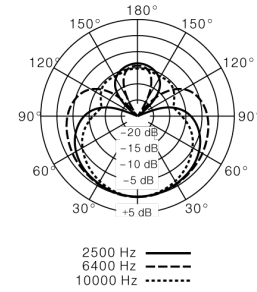
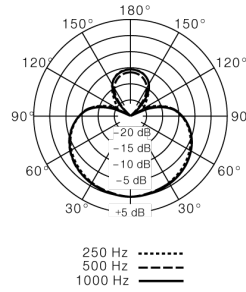
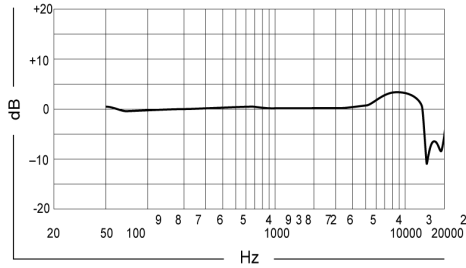

Beta 181/S

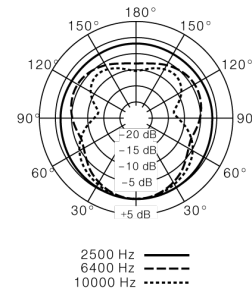
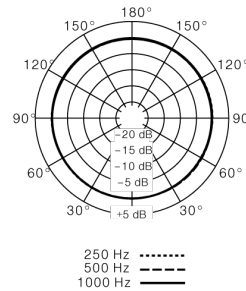
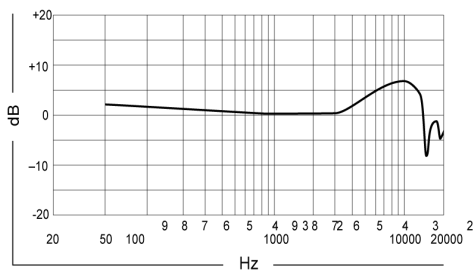

Beta 181/O

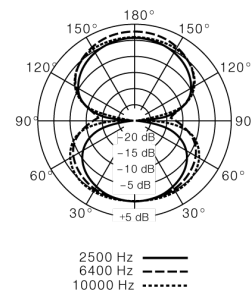
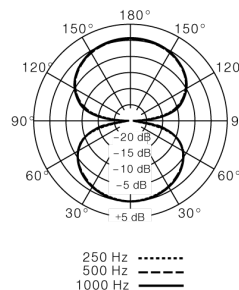
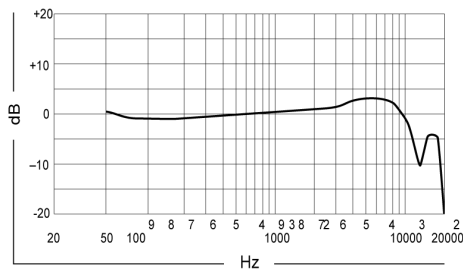

Beta 181/BI

Accessories

Furnished Accessories

Microphone Clip for AMS26, BETA181, KSM137, KSM141, MX412, MX418, MX412S, MX418S, MX412SE, MX418SE, SM62, SM63, SM63L, SM63LB, SM81, VP64, VP64A, VP64AL and standard microphone stands	A57F
Foam case assembly for BETA181	A181C
Foam Windscreen for BETA181	A181WS

Optional Accessories

BETA181 Cardioid Capsule	RPM181/C
BETA181 Supercardioid Capsule	RPM181/S
BETA181 Bidirectional Capsule	RPM181/BI
BETA181 Omnidirectional Capsule	RPM181/O
BETA181 Preamplifier	RPM181/PRE
Universal Microphone Mount with Large and Small Clip Adapters and Universal Threaded Adapter Post	A75M
Isolation Mount/Swivel Adapter for KSM109, KSM137, KSM141, SM63, SM81, SM94 and VP64	A53M
25 foot (7.5m) Triple-Flex[®] Microphone XLR Cable with Switchcraft connectors	C25E

Certifications

CE Notice

Hereby, Shure Incorporated declares that this product with CE Marking has been determined to be in compliance with European Union requirements.

The full text of the EU declaration of conformity is available at the following site: <https://www.shure.com/en-EU/support/declarations-of-conformity>.

UKCA Notice

Hereby, Shure Incorporated declares that this product with UKCA Marking has been determined to be in compliance with UK-CA requirements.

The full text of the UK declaration of conformity is available at the following site: <https://www.shure.com/en-GB/support/declarations-of-conformity>.